

STRICTLY CONFIDENTIALFOR APPOINTED PHILIPS
DEALERS ONLY

COPYRIGHT 1938

PHILIPS
SERVICE MANUAL

FOR RECEIVER

Types 555A and 555U

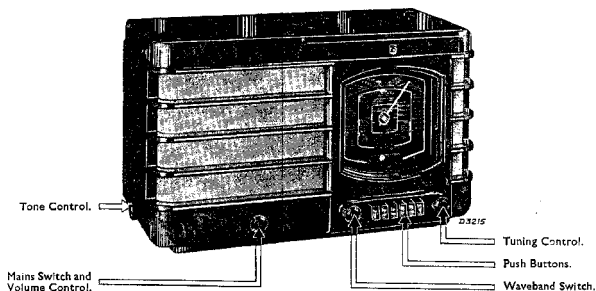

The A type receivers are suitable for use on alternating current mains and the U type on direct current mains.

GENERAL.

These superheterodyne receivers incorporate the following features :—

Band filter pre-selection.

7 tuned circuits.

I.F. aerial filter for suppression of signals at this frequency.

Image frequency filter.

Delayed automatic volume control.

Continuously variable tone control.

Push Button Tuning (6 push buttons which can be set to any required station).

Visual tuning with electron indicator.

Large indirectly lighted station scale.

Connection for extension speaker.

Connection for gramophone pick-up.

Safety contact, ensuring that the receiver is not under voltage when the backplate is removed.

Mains tapping plate for voltages of 110 to 245 v.

Wave Ranges :—

S.W. : 16.7—51 m. (17.96—5.88 M.C.).

M.W. : 198—585 m. (1.515—512.8 K.C.).

L.W. : 708—2,000 m. (423.7—150 K.C.).

Weights :—

555A, 29 lb. } including valves.

555U, 32 lb. }

Dimensions—555A, 555U :—

Width, 19½ in.

Height, 11¼ in.

Depth, 9½ in.

} Including knobs.

DESCRIPTION OF CIRCUIT.**Short Wave.**

Aerial circuit : S12 inductively coupled with S13.
 Grid circuit of L1 : S13, tuning condenser C8 and C32.
 Oscillator grid circuit : S18, tuning condenser C9,
 grid condenser C29, grid leak R6.
 Oscillator anode circuit : S29, R25.

Medium Wave.

Aerial circuit : S6 coupled inductively and
 capacitively (C14) with S8.
 Band filter : 1st circuit : S8, tuning condenser C7,
 trimmer C10, coupling condenser C10, coupling coil
 S30.
 2nd circuit : Coupling condenser C16, coupling coil
 S31, S10, tuning condenser C8, trimmer C11.
 Oscillator grid circuit : S14, tuning condenser C9,
 trimmer C11, padding condenser C20.
 Oscillator anode circuit : S15, R19.

Long Wave.

Aerial circuit : S6-S7 coupled inductively and
 capacitively (C14) with S8-S9.
 Band filter : 1st circuit : S8-S9, tuning condenser C7,
 coupling condensers C15-C16.
 2nd circuit : coupling condensers C15-C16, S10-S11,
 tuning condenser C8.
 Oscillator grid circuit : S14, S16, tuning condenser
 C9, trimmer C12 (C31), padding condenser C19 (C20).
 Oscillator anode circuit : S17, S15, R19.

Note.—In the M.W. and L.W. ranges C29 is short-
 circuited and the padding condensers serve as grid
 condenser. R14 prevents parasitic oscillation of the
 pentode of L1.

Image Frequency Filter.

C17 together with the 1st circuit of the band filter
 forms a filter for the suppression of signals at a
 frequency which is higher than that to which the
 band filter is tuned by twice the I.F., these voltages
 being prevented from reaching the coupling con-
 densers or the mixer valve.

I.F. Circuits.

Aerial filter : S29, C37.
 1st Band filter : S20, C21, S21, C22.
 2nd Band filter : S22, C23, S23, S24, C24.

Detector Circuit and A.F. Amplifier.

The first anode of the diode L3, cathode, R10 (volume
 control), R8 and S24 comprise the detector circuit.
 C25 short-circuits the I.F. from R8 and R10. The
 A.F. voltage across R10 passes via C26 and R11 to
 the grid of L3. C27 diverts any residual I.F. voltage,
 R11 prevents oscillation of L3 and S25-S26 is the
 speaker transformer.

Variable Tone Filter. R17, C35, R18.**Automatic Volume Control.**

The second anode of the diode L3 is connected via
 C50 to S22, producing a direct voltage across R5
 which is proportional to the signal strength and
 which controls the amplification of L2 via R9 and C5,
 and also that of L1 via R4. The control is delayed
 by the voltage across R13-R15.

Visual Tuning.

A portion of the direct voltage rectified by the first
 anode of L3 is taken from the potentiometer R22,
 R23 (C41) and passed to the control grid of L5. On
 an increasing signal strength the negative bias on
 the control grid of L5 also increases, with a reduction
 in the anode current. The potential difference across
 R24 thus becomes smaller, i.e., the potential difference
 between the screen of L5 and the deflector plates
 connected to the anode is reduced. The screening
 effect of the deflector plates being thus reduced, the
 width of the light bands on the screen becomes
 greater. The receiver is correctly tuned when the
 width of the green bands reaches maximum.

Feeding.

Mains transformer S1, S2, S3, S4.
 Ripple condenser C38.
 Smoothing filter C1, S41, C2.
 Voltage for grid 2 of L1 : via R3-C4 and for grids
 3 and 5 further via R21-C40.
 Anode voltage for L1 and L2 as well as screen voltage
 for L3 and L5 : direct from C2.
 Screen voltage for L2 : via R20-C39.
 Anode voltage for L3 : direct from C1.
 Anode voltage for L5 : via R24.

Push Button Tuning. See G sheets.

Receivers for D.C. Voltages.

NOTE :—Fig. 11a shows the difference between the
 U and A types of receiver. Reference should be
 made to Service Manual for Converter Unit Type
 7880C/7881C.

TRIMMING THE RECEIVER.

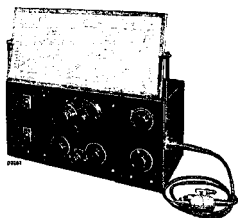

Fig. 1.

General.

It is necessary to uncase the chassis if the whole receiver is to be retrimmed (see G sheets), as the oscillator trimmer for the L.W. range (wire wound trimmer) is mounted under the chassis.

Wire Wound Trimmers.

These consist of bushes of R.F. insulating material sprayed internally with a layer of metal and covered on the outside with a winding of copper wire, the capacity being reduced as required by unwinding the wire. In trimming, the wire is unwound until the output indicator, after having reached maximum deflection, commences to drop back; turns are then replaced, the wire being clipped off and the end fixed with a little wax.

If maximum cannot be obtained by unwinding the wire, this means that the capacity is too small and a new trimmer must be fitted. Extra wire must not be added to the trimmers to increase a capacity that is too small as it is possible that extra turns would not be tight enough and consequently cause instability.

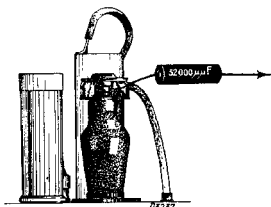

Fig. 2.

Retrimming is necessary.

1. After changing coils or condensers in the I.F. or R.F. sections.
2. When the receiver is insufficiently sensitive or selective (see sheet E1).

The following equipment is required for trimming—

1. Service oscillator GM2880F (see Fig. 1).
2. Output indicator: Universal testboard types 4256 or 7629 (see Fig. 7).
3. Aperiodic amplifier GM2404.
4. Test bridge GM4140.
5. Insulated trimming key.
6. Trimming transformer.
7. Condensers of $0.1 \mu\text{F}$ and $32,000 \mu\text{F}$.
8. Resistances of 50,000 and 80,000 ohms.

Artificial Aerials.

1. For I.F.: a $32,000 \mu\text{F}$ condenser.
2. For M.W. and L.W.: standard artificial aerial supplied with GM2880F.
3. For S.W.: a S.W. artificial aerial; standard artificial aerial with red spot.

Always trim the receiver with its own valves.

Before trimming is commenced, the locking wax must be removed from the trimmers with a pair of tweezers and the trimmers moved up and down a few times to remove all traces of the wax. After trimming, these must again be locked with wax, e.g., by holding the wax against a warm iron so that a few drops of the wax fall on to the centre of the trimmer.

A. I.F. Circuits.

1. The Band Filters.

1. Earth the receiver and switch to L.W. (lower end, about 700 m.).
2. Turn volume control to maximum.
3. Connect output indicator across trimming transformer to the extension speaker terminals.
4. Apply modulated 128 K.C. signal across $32,000 \mu\text{F}$ to top of L1 (see Fig. 2).
5. Connect 50,000 ohms resistance across C22 and 80,000 ohms across C23 (see Fig. 3).
6. Trim C24 and then C21 for maximum output (see Fig. 4).
7. Remove damping resistances from C23 and C22.
8. Damp C21 with 50,000 ohms resistance and C24 with 80,000 ohms (see Fig. 3).
9. Trim C22 and then C23 for maximum output (see Fig. 4).
10. Remove damping resistances.

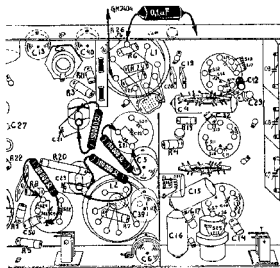

Fig. 3.

II. The Aerial Filter.

1. Connect the modulated I.F. signal via standard artificial aerial to the aerial socket.
2. Tune receiver to upper end of L.W. (about 2,000 m.).
3. Trim C37 for minimum output.

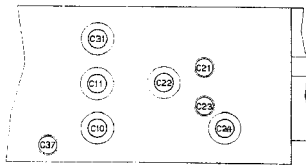

Fig. 4.

B. R.F. and Oscillator Circuits.

Before trimming the R.F. and oscillator circuits is commenced, the tuning condenser must be set to a certain capacity by depressing one of the push buttons, as follows:—

1. Unsolder the leads on C9.
 2. Connect GM4140 by means of the shortest possible leads to C9.
 3. Turn variable condenser to minimum.
 4. Depress fourth push button from the left and by means of the push button setting key (for Code No. see sheet O2), accurately adjust C9 to 28.3 μ F.
 5. Disconnect GM4140 and resolder the leads to C9.
- Note.**—Do not disturb the adjustment of push button 4 until the receiver has been completely retrimmed.

I. Medium Waves.

1. Earth the receiver and switch to M.W.
2. Set volume control to maximum.
3. Connect output indicator across trimming transformer to the extension speaker sockets.
4. Set condenser to minimum and depress push button 4.
5. Apply modulated signal of 1,400 K.C. (214.3 m.) across standard artificial aerial to the aerial socket.
6. Trim for maximum output in that order C31, C11, C10, C31, C11 (see Fig. 4).
7. Set receiver for manual tuning.

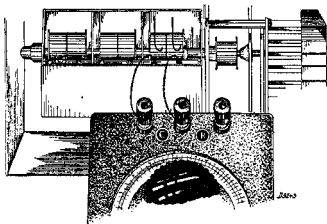

Fig. 5.

II. Long Waves.

1. Earth receiver and switch to L.W.
2. Set volume control to minimum.
3. Connect aperiodic amplifier GM2404 to anode of L1 (see Fig. 3).
4. Connect output indicator to GM2404.
5. Earth the first grid of the mixing valve through a condenser of 0.1 μ F (see Fig. 3).
6. Apply modulated signal of 390 K.C. (769.2 m.) via standard artificial aerial to aerial socket.
7. Tune the receiver to be trimmed for maximum output by means of the tuning knob (variable condenser).
8. Disconnect aperiodic amplifier and short-circuit from the first grid of L1.
9. Connect output indicator across trimming transformer to the extension speaker sockets.
10. Set volume control to maximum.
11. Trim C12 for maximum output (see Fig. 3).

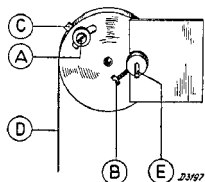

Fig. 6.

C. Calibration. (2-point).

Before calibration of the scale is undertaken, the tuning indicator and pilot lamps must be placed outside the cabinet and the H.T. section so covered that none of the parts which are under voltage can be touched.

1. Connect output indicator to the extension speaker terminals across the trimming transformer. Set wavelength switch to M.W.
2. Apply modulated signal of 588 K.C. (510 m.) via standard artificial aerial to the aerial socket.
3. Carefully tune the receiver by means of the manual tuning knob.
4. Loosen screw A (Fig. 6) and turn the pointer drum so that the pointer indicates exactly 510 m., holding the lug C to keep the driving cord D taut. Take care that the tuning does not alter and again tighten screw A.
5. Apply modulated signal of 1,200 K.C. (250 m.) to the aerial socket.
6. Tune the receiver.
7. If the pointer does not tally with the 250 m. mark, adjust screw A to the extent of half the amount of deviation, on the other side of the 250 m. For instance, if the pointer shows 238 m., adjust the pointer by means of screw A to 256 m.
8. Loosen screw B, turn the pointer spindle E until the pointer indicates 250 m. and tighten screw B.

9. Check the indication at 510 m. and if necessary repeat the above operations.

Note.—If screw A cannot be moved far enough, drum G (Fig. 8) should be turned slightly in the following manner :—

1. Remove the knobs.
2. Loosen the bottom screws.
3. Tilt the chassis slightly to the rear.
4. Loosen the 2 grub screws holding the drum on the spindle.
5. Turn the drum taking care that the spindle does not move.
6. Refix the drum.

Before proceeding with calibration of the scale, replace the chassis in its original position.

Setting the Push Buttons.

1. Remove the ornamental cap from the button concerned. This can be done easily by depressing the buttons on each side of the one to be set.
2. Tune the receiver by means of the manual knob to the required station (push buttons out).
3. Depress the push button in question.
- 4 (a) If the tuning remains correct, the set screw A (Fig. 8) should be adjusted with the aid of a key until the tuning is no longer audible.
(b) If the tuning of the receiver changes, set screw A (Fig. 8) is again adjusted until the required station is audible.
5. Move the pointer to the extreme left by turning the manual control knob.
6. Adjust set screw A so that the receiver is tuned exactly to the desired station.

Note.—It is always desirable to adjust the centre set screws to the lowest wavelengths.

FAULT FINDING.

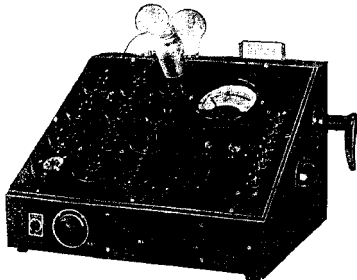

Fig. 7.

A good measuring instrument is essential for efficient fault finding and use should, therefore, be made of universal testboard Type 4256 or 7629. In order to localise faults, it is advisable to uncase the chassis as all components will then be accessible (see "Uncasing," G sheets).

No connections should be unsoldered before the fault has been localised by measurements. Current and voltage values are given in the table in the S sheets. These instructions are not comprehensive seeing that any combination of faults may occur.

I. Connect receiver to the correct voltage and test with its own valves on outdoor aerial or service oscillator.

(a) If the receiver works normally, leave it working under observation.

(b) If the receiver works badly or not at all: see below.

II. Replace the valves by a set taken from a good receiver and if necessary try out with another speaker.

Faults in valves or speaker are thus eliminated or localised.

III. Test for Gramophone Reproduction.

(a) If reproduction is possible the fault will be found in the I.F. or R.F. section (see Para. V).

(b) If no reproduction obtained, the fault is to be found in the A.F. or Feed section (see Para. IV).

IV. No radio or gramophone reproduction.

(a) Abnormal voltage across C2.

1. Safety contact, mains switch, tapping plate or S1 defective: measure voltage across the whole of the primary. (Should be 245 v.).

2. S3 defective: measure voltage at the heater sockets of L4 (4 v.).

3. S2 defective or C38 short: measure voltage across the 2 halves of S2 (2 x 250 v.).

4. C1 or C2 short.

5. S41 open.

6. L3 giving abnormal currents: see below.

7. Short to earth in the screen of S20 or S22.

8. S25 shorting to S26 or laminations.

(b) L3 giving abnormal currents and voltages.

1. S25, R13, R15 open: no anode current: C27 short; anode current too high.

2. C28, C26 short: anode current too high.

3. R11, R12 open.

(c) L3 giving normal currents and voltages but gramophone reproduction not possible.

1. C36 short.

2. Shorted turns in S25 or S26: R10, C26, S26 open.

V. Gramophone reproduction but no radio reception.

(a) L2 giving abnormal currents and voltages.

1. S22, R7, R20 open; C39 short: no anode current or current too low.

2. C6 short: anode current too high.

3. R9, R5, S21 open.

(b) L1 giving abnormal currents and voltages.

1. S20, R1, R21, R3 open; C4, C40 short: no anode current or current too low.

2. C13 short: anode current too high.

3. R26, R6, R4, R14 open.

(c) L1 and L2 giving normal currents and voltages.

1. No reproduction of modulated I.F. signal applied to control grid of L2 (top connection): S23, S24, R8 open.

2. No reproduction of modulated I.F. signal applied to control grid of L1 (top connection): C22, C21 short.

3. I.F. signal is reproduced but no R.F. applied to control grid of L1: one of the coils or condensers in the oscillator section shorting or open; switch unit 2 making bad contact.

4. Reproduction of signal as in Para. 3 but not when applied to aerial socket: coil or condenser in the R.F. band filter or aerial circuit short or open; R14 shorting to the screening; switch unit 1 making bad contact.

VI. Radio and Gramophone reproduced but quality not good.

(a) A.V.C. not working.

1. C50 open.

2. C5 short.

(b) Excessive background noise.

Circuits out of alignment: retrim (see C sheets).

(c) Low selectivity.

1. Circuits out of alignment: retrim (see C sheets).

2. Shorting turns in one of the I.F. coils: this is indicated when it is found impossible to obtain a sharp maximum from the circuit in question.

(d) Oscillation.

Screened grid lead of L1 making bad contact to chassis.

(e) Hum.

C1 or C2 faulty.

(f) Visual tuning not working.

R22, R23, R24 open; C41 short.

FAULT FINDING IN ACCORDANCE WITH THE "POINT TO POINT" SYSTEM.

If either of the testboard Types 7629 or 4256 is available, faults can be easily localised by making use of the "Point to Point" system. The preliminary operations in this case are practically the same as those mentioned in the E sheets, to which reference should be made, see Paras. I and II. Then proceed as follows:—

1. Disconnect the receiver from the mains and remove all the valves.
Connect the universal testboard Type 7629 or 4256 and set the testboard for resistance testing, successively to positions 12, 11, 10 and 9. The positive pin on the test lead should be extended to reach the various valveholder contacts without difficulty, the negative pin being connected to earth socket of the chassis.
2. The contacts of the rectifier socket must be shorted. This also protects the meter as otherwise there would be a risk of the smoothing condensers becoming charged, with consequent damage to the meter.
3. The various resistance values between the points indicated in the accompanying table and the chassis are measured by touching the point indicated with the positive pin, the meter deflection being compared with the value given in the table. P indicates that the test must be made between the pick-up sockets and earth, etc.. 11/12 means that the test is to be made between points 11 and 12. Differences of 10 per cent. may be met with, but these do not necessarily indicate that the particular component is defective.
4. When all the resistances have been measured, the testboard is adjusted for capacity testing and the various capacities are then measured in accordance with the table.

As practically all parts of the circuits are measured in this way, the fault will usually be found and the faulty component can be identified by means of the circuit.

If the fault is still undetected, it is advisable to repeat the tests indicated in the E sheets. The valveholder contacts are numbered systematically in the following manner.

The first figure indicates the valveholder and the second figure one of the following:—

- 1 and 2 = filament.
- 3 = control grid.
- 4 = contact for metallising (if separate).
- 5 = cathode.
- 6 = extra grid.
- 7 = screen grid.
- 8 = anode.
- 9 = extra grid (e.g. in octode).

It is necessary for some of the tests to change the setting of the wavelength switch, and this is indicated in the table as follows:—

3 × 19

In testing electrolytic condensers (resistance tests) it will be found that the deflection drops back to a certain value due to the fall in the leak current. The value obtained may be much too high owing to the condenser being defective, but may also be due to the fact that the receiver has not been used for a considerable time. It is, therefore, necessary to exercise some care in judging the condition of these condensers.

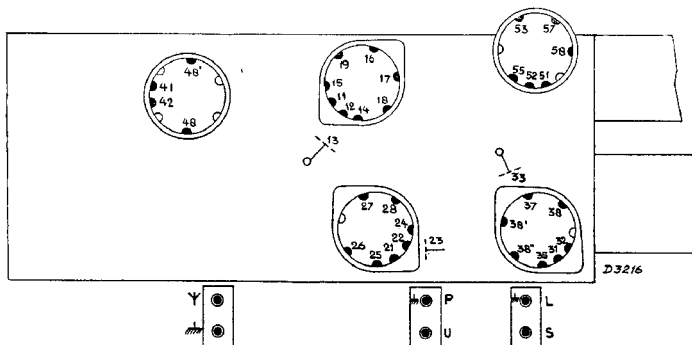

RESISTANCES.

12	11/12	51/52	11	14	24	3 × Aerial			P	L	S	57	37					
	10			10	10	10	SW	MW	LW	10	10	35		5				
11	13	15	25	26	35	38	48	48'										
	SW	335	305	305	375	390	255	255										
10	16	18	3 × 19			27	28	37										
	145	450	SW	MW	LW	100	445	445										
9	2 × 13	17	23	33	38'	38*	41	U	U	57	53	53	55					
	MW	LW	340	70	140	205	220	370	230	135	80	200						

CAPACITIES.

12	33	38'																
	220																	
11	17	23	27	53	55													
	140	205	150	105														
9	18	35	57															
	355	490	475															

Receiver set to M.W. 585 metres. Volume control set to maximum. Tone control set to high.

REPAIRS AND REPLACEMENTS OF COMPONENTS.

The following points must always be borne in mind:—

1. When completing repairs always restore wiring and screening to their original positions.
2. Replace spring washers, washers and insulating material as they were before repairs were started.
3. Rivets which have been removed may be replaced by screws and nuts.
4. Lubricate moving parts with a little pure vaseline where necessary.
5. Solder all compounded condensers at least 1 cm. from the compound.
6. Compounded condensers must always be suspended free from other wiring.
7. Always fit resistances clear of other components (dissipation of heat).

UNCASING THE CHASSIS.

1. Remove the backplate.
2. Take off the knobs.
3. Loosen tuning indicator and pilot lamps.
4. Slacken off screw B (Fig. 6).
5. Detach cable from pointer drum.
6. Unsolder the speaker.
7. Loosen the bottom screws.
8. Slightly push out the chassis.
9. Detach indicator cable from scale.
10. Remove chassis from the cabinet.

Reassembly of the chassis in the cabinet presents no difficulties except in regard to the fixing of the cable to the pointer drum. This is done in the following manner:—

1. Set variable condenser to maximum.
2. Wind up pointer drum about 4 turns (direction from 200 m., through 300 m. to 500 m.).
3. Attach cable to the drum.

RENEWING SCALE AND POINTER.

1. Uncase the chassis.
2. Take out the six screws holding the screen box to the cabinet. The screen box is removed and both scale and pointer can then be easily renewed.

WAVELENGTH SWITCH IN THE THEORETICAL CIRCUIT.

The switches are drawn as seen from the control end, the chassis being vertical.

The switch units are numbered from the control end and the position of the stop ball is indicated in the diagram of the first switch unit.

The outline of the stator of each of the units is shown at 90° to the left of the stop ball. Rotors are drawn in the extreme left-hand position, as shown by the arrows drawn round the hole in the rotor.

Contact springs are represented by circles, and open points on the stator by dots. The outer ring of circles indicates the contact springs on that side which is facing the stop plate and the inner ring of circles those on the remote side. The rotor contacts are represented by arcs and radial lines—as full lines on the same side as the stop plate and as dotted lines on the remote side. Switch units are replaced complete. (For Code Nos. see O sheets).

DESCRIPTION OF THE TUNING MECHANISM.

A. Push Button Tuning.

Before tuning can be effected by means of the push buttons, the pointer must be moved over to minimum wavelength by turning the knob.

When one of the push buttons is depressed, the tapered end of the plunger B first pushes stop plate E to the left. This stop plate is then pressed back by the spring F and engages in the groove in the plunger B and retains the push button.

In the meantime, set screw A at the end of the plunger B moves the thrust plate C forward, this movement being transmitted to the variable condenser by the spindle D.

Depression of another push button again pushes stop plate E to one side, thus releasing the first button which returns to its normal position.

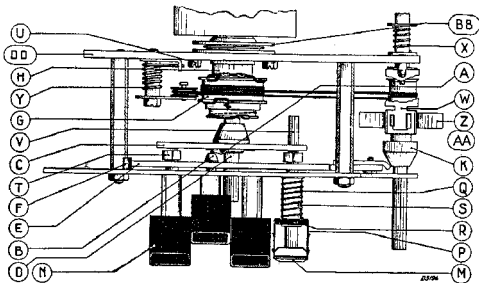

Fig. 8

B. Manual Tuning.

To tune the receiver by means of the manual tuning knob, the knob must first be pulled once so that lug K pushes the thrust plate E and releases any push buttons that may be already depressed.

The rotary movement of the knob is transmitted to the drum G by the driving cord and a worm converts this rotary movement to a lateral movement of the hollow spindle H, thus opening or closing the condenser.

To demount tuning unit with variable condenser from the chassis—

1. Uncase the chassis.
2. Unsolder the leads to the variable condenser.
3. Loosen the pertinax strip on the condenser (one screw).
4. Loosen the four bolts by which the unit is held to the front plate of the chassis and take off the unit.

To renew the variable condenser—

1. Demount the tuning unit with variable condenser from the chassis in the above manner.
2. The variable condenser is fixed to the backplate of the tuning unit with three hex. headed screws. Upon removal of the latter, the condenser can be taken off and replaced.

Care must be taken that the spring on the condenser carrying the larger (approx. $\frac{3}{8}$ ") fork mounted on the driving spindle is fitted inside the fork inside the condenser housing. The other side of the fork lies outside the housing. Where the condenser has a smaller bracket fitted (approx. $\frac{1}{8}$ ") both sides of the "V" shaped spring run on the inside of the brass contact guides.

To renew parts of push buttons—**A. Ornamental Cap (M).**

This cap is simply pulled off the button. To facilitate this, the two adjacent buttons should be depressed.

B. Plunger (B).

The plungers can be removed by straightening the lugs in the plate M. It is not necessary to uncase the chassis to do this.

C. Bronze Flat Spring (P) under Ornamental Cap and Spiral Spring (Q) behind Push Button.

1. Uncase the chassis.
2. Remove plunger B (see above).
3. Clip through plate R and flat spring P and discard.
4. Renew the spiral spring Q.
5. Fit new flat spring P to the bush.
6. Place rubber washer on the bush.
7. Fit new plate R.
8. Close up aperture in plate R with solder.

Note.—In some receivers Plate R and the ring behind it have been omitted, but a new plate R should, nevertheless, be fitted when repairs to push buttons are carried out.

Backlash on Manual Tuning.

This may be caused by the following:—

1. Cord tensioning bracket too slack.
2. Fork inside the variable condenser not gripping the fork on hollow spindle H (Fig. 8). See remarks on Renewal of Variable Condenser.
3. Spring at the end of the variable condenser for pushing back the rotor spindle may be too weak or defective and should be changed. This spring will be found inside the cap at the rear end of the condenser.
4. Worm transmission may be defective. Renew backplate with transmission mechanism and thrust plate C.

Depressed Push Button does not return to neutral when a second button is operated.

This may be caused by the cap being too large or fitted at an angle or an incorrect setting of the stop plate. In the latter case the two nuts between the rows of push buttons should be loosened slightly and the stop plate so adjusted that the trouble is removed. The nuts must be properly tightened again.

The corners of washer "R" may be found distorted.

RENEWING COILS.

1. Unsolder the leads.
2. Slightly open up the lugs holding the coil to the chassis.
3. Remove the coil.
4. Fit new coil.
5. Renew between the lugs by means of a lever. If the lugs are broken off, coils may be fixed with special clips (for Code Nos. see O sheets).

LENGTH OF CABLES.

Cord	62 cm.
Drive Cable	27.5 cm.
Indicator Cable	15.5 cm.

FITTING CABLE DRIVE.

1. Secure one end of cable on pin of brass drum.
2. Feed cable in same direction and same groove as cord drive until first slot is reached.
3. Pass through slot and continue to wind one turn approx.
4. Hold cable, turn variable condenser to maximum capacity, and allow cable to wind on drum.
5. Give cursor 3-4 turns anti-clockwise to tension spring loading, and then hook cable to drum.

Note.—If a pulley is fitted to chassis, cable should pass round pulley on side nearest to mains transformer.

FITTING CORD DRIVE.

With the gang condenser at minimum and facing push button assembly proceed as follows :—

1. Secure cord under screw head in brass drum.
2. Wind clockwise and pass through first slot into first groove taking three complete turns.
3. Lead off over and round spindle $2\frac{1}{2}$ turns, winding towards you.
4. Lead across under and around tension pulley, thence back to drum, making one turn, then to second slot feeding into middle groove, and on to pin.

LOUDSPEAKER. Type 9636.

Before repairs to the loudspeaker are undertaken it should be definitely ascertained that the speaker is at fault (try out with other speaker and transformer). Rattle and resonances may be caused by the following :—

1. Loose components in the cabinet.
2. Leads too slack.
3. Leads too taut.

If repairs are found necessary the following must be borne in mind :—

1. The bench must be quite free from dust.
2. The front and backplates of the magnet must never be removed.
3. The cause of the trouble may be due to—
 - (a) Dirt in the air gap.
 - (b) Jammed or distorted speech coil.
4. The dust cover must be replaced as soon as repairs are completed.

Four feeler gauges must be used if the speech coil is to be recentred in the air gap.

For replacement of the speaker chassis or recentring of the core in the air gap a special centring jig is required. When the cone is moved up and down with the speaker held close to the ear, no sound must be audible.

LIST OF COMPONENTS AND TOOLS.

When ordering, please always state :—

1. Code No.
2. Description.
3. Type No. of receiver (555A, 555U).

Fig.	Pos.	Description.	Code No.
9	1	Cabinet	23.660.733
		Base Board for Cabinet	28.404.890
9	2	Speaker silk (per metre)	06.601.200
9	3	Knob (colour 041)	23.611.610
9	4	Escutcheon (colour 041)	28.678.072
9	5	Knob (colour 041)	23.611.340
9	6	Station Pointer	28.945.611
9	7	Trade Mark Disc	28.713.271
9	8	Station Scale	A1.890.920
10	9	Pilot Lampholder	08.515.211
		Plate with pins for A set	28.875.400
10	10	Plate with pins for U set	28.875.490
10	11	Clip	28.752.072
10	12	Plug socket plate	28.875.190
10	13	Valve cap	28.838.741
10	14	Knurled screw	07.742.000
10	15	Valveholder	28.226.100
10	16	Torsion spring	28.760.420
		Backplate 555A	28.405.840
		Backplate 555U	28.406.060
		Leather Hinge for backplate	28.285.660
		Station Label for push button	A1.860.321
		Bush 7 × 1	25.655.460
		Bush 3.5 × 1	25.655.690
		Bush 9 × 1	25.655.570
		Mains lead (per metre)	33.981.080
8	BB+DD	Driving mechanism assembly	A9.861.020
8	A	Set screw	28.647.463
8	B	Tumbler pin with plate	28.828.270
8	F	Flat spring for stop disc	28.753.392
8	N	Cap for push button	23.667.063
		Celluloid plate for push button	28.286.823
8	P	Bronze flat spring for push button*	28.087.250
8	Q	Spiral spring for push button	28.731.234
8	R	Plate under push button cap†	28.086.535
8	T	Short bolt for stop disc	28.647.643
8	U	Hex. headed screw for fixing sliding condenser	07.840.280
8	V	Long bolt for stop disc	28.647.533
8	X	Spiral spring for end of driving spindle... ..	28.731.241
8	Y	Spring for cord tensioning bracket	28.760.431
		Spindle for Volume Control	28.000.550
		Z2 fuse for 555U	08.140.391
		Safety contact for 555U	28.839.510
		Housing	23.660.592
		Plate	28.713.240
		Flat spring	28.753.021
		Flat spring	28.753.031
		Ch/hd. Screw	07.803.200
		Bridge spring	28.760.440
		Switch Unit I‡	25.873.600

LIST OF COMPONENTS AND TOOLS—continued.

Fig.	Pos.	Description.	Code No.
		Switch Unit II†	25.873.570
		Ball for wavelength switch	89.205.800
		Speaker- chassis	28.256.170
		Spinning ring	25.871.810
		Paper ring	28.451.540
		Bridge	28.682.080
		Converter unit 110 v.	7880C-15
		Converter unit 220 v.	7881C-15
		TOOLS.	
1		Service oscillator	GM.2880F
		Universal testboard	Type 4256
7		Universal and valve testboard	Type 7620
		Aperiodic amplifier	GM.2404
		Insulated trimming key	M.646.565
		Insulated trimming screwdriver	M.646.382
		Trimming transformer	09.992.220
		Circuit tester	09.991.590
		Lever for fixing coils	09.991.560
		Centring jig for loudspeaker	09.991.530
		Clamps for fixing coils	28.080.870
		Philifine 110 for sealing trimmers	02.771.340
		Locking wax for I.F. coils	02.851.360
		Key for setting push buttons	28.914.691

† For numbering of switch units see Circuit.

* File out corners square to enable spring to pass over the square pin.

† Cut open the plate on one side and close with solder when assembled.

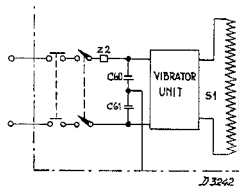

Fig. 11a

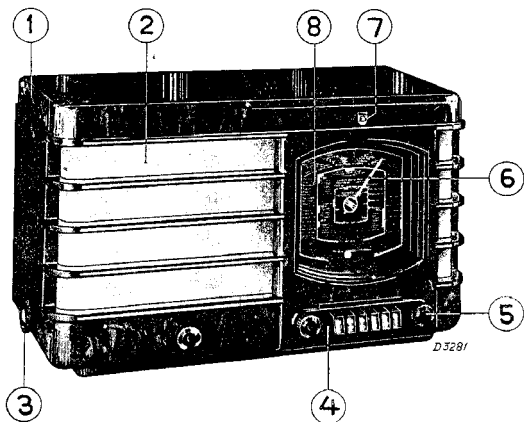

Fig. 9

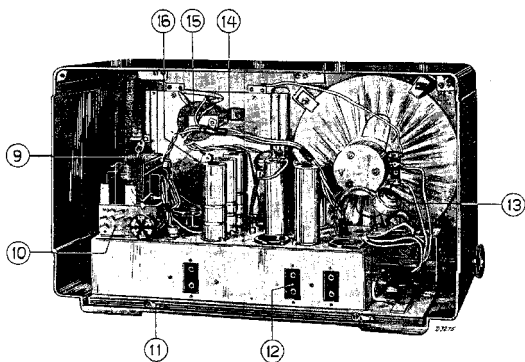

Fig. 10

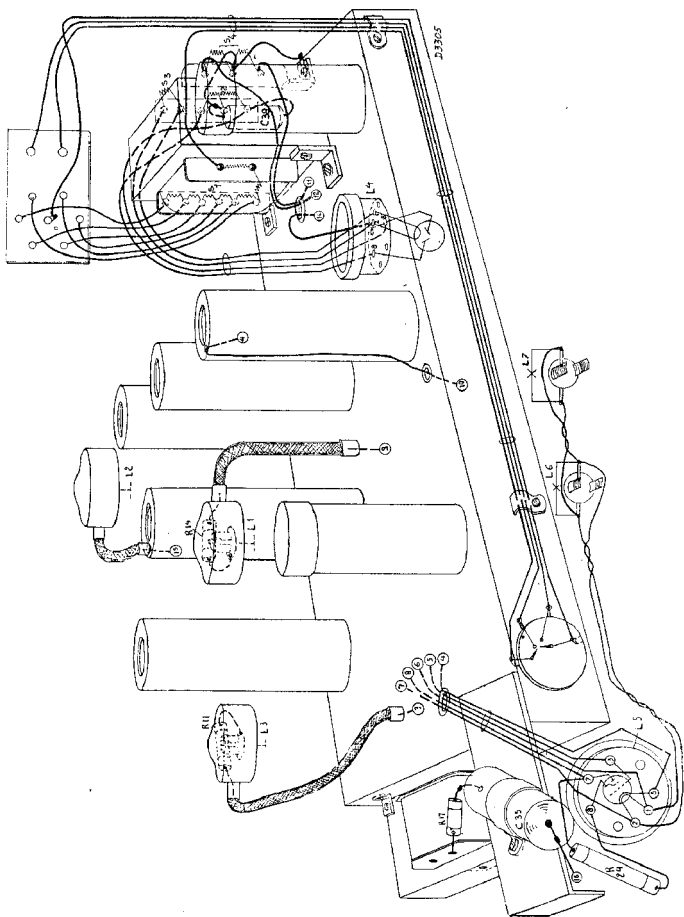
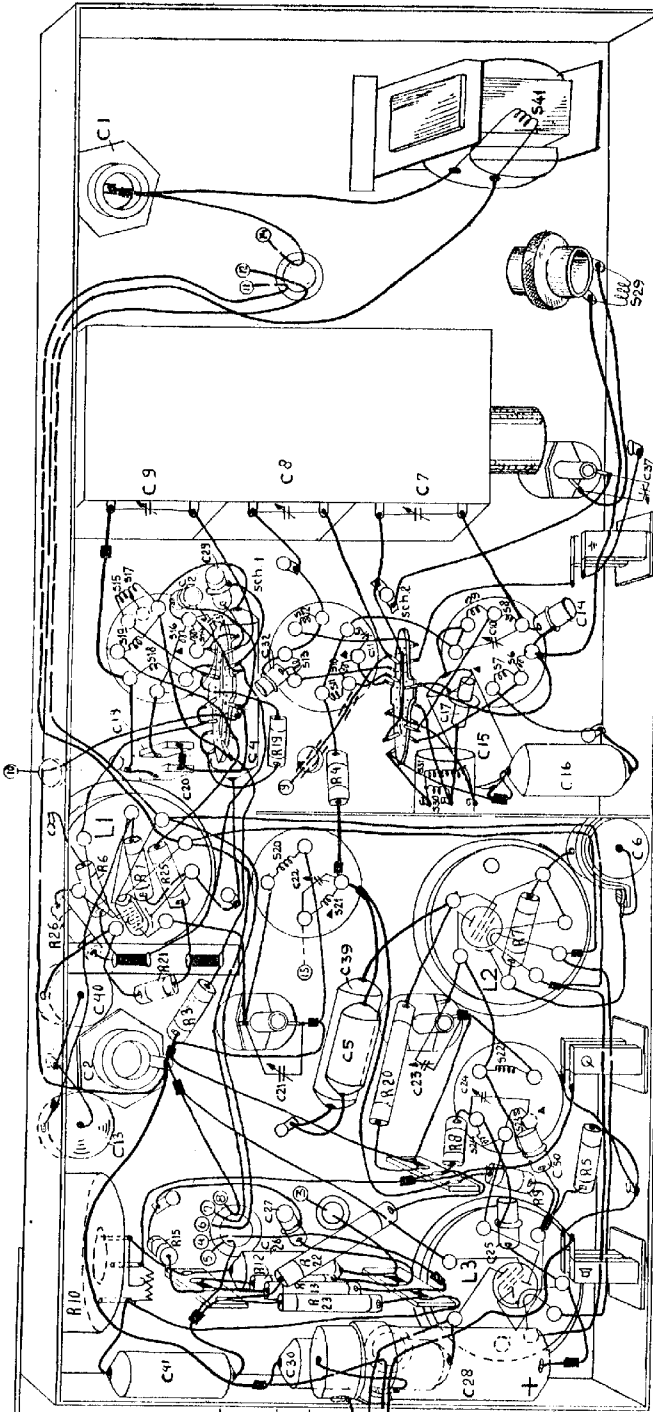

Fig. 12.



COILS.

Designation.	Value.	Code No.	Designation.	Value.	Code No.
Z2		08.140.390	S20	130 Ohm	28.572.912 555A
S1	48.5 Ohm	28.538.210	S21	130 Ohm	
S2	375 Ohm		C22	30+70 $\mu\mu\text{F}$	28.574.440 555U
S3	<1 Ohm	S22	130 Ohm		
S4	<1 Ohm	S23	35 Ohm	28.572.902	
S6	30 Ohm	S24	90 Ohm		
S7	90 Ohm	C24	30-70 $\mu\mu\text{F}$	28.537.691	
S8	4.5 Ohm	S25	690 Ohm		
S9	40 Ohm	S26	1 Ohm	28.220.510	
C10	30 $\mu\mu\text{F}$	S27	4 Ohm		
S10	4.5 Ohm	S28	100 Ohm	28.587.880	
S11	40 Ohm	S30	1 Ohm	28.587.710	
S12	2.5 Ohm	S31	1 Ohm		
S13	<1 Ohm	S41	350 Ohm	28.546.081	
C11	30 $\mu\mu\text{F}$				
S14	11 Ohm				
S15	7.5 Ohm				
S16	40 Ohm				
S17	4 Ohm	28.573.860			
S18	1 Ohm				
S19	<1 Ohm				
C31	30 $\mu\mu\text{F}$				

CURRENTS AND VOLTAGES.

	L1	L2	L3	L5	
Va	280	280	250	—	Volts.
Vg2	175	115	280	280	Volts
Vg3-5	45	—	—	—	Volts
-Vg †	1.5	2.6	20	—	Volts
Va''	—	—	0.5	—	Volts
Ia	2.0	6.0	33	—	Milliamps
Ig2	1.6	1.8	5.8	—	Milliamps
Ig3-5	1.5	—	—	—	Milliamps

† Cathode chassis.

Voltage at C1 = 292 volts.

Voltage at C2 = 258 volts.

The above values are measured without signal at the aerial socket, the measurement being made between the point indicated and the cathode. The test instrument used was Type 4256 or 7629; the resistance of the voltmeter in these testboards is 2,000 ohms per volt and if voltmeters having lower internal resistance are used, the results obtained will, generally speaking, also be lower. The above values are averages taken from a large number of receivers so that discrepancies may be met with which do not necessarily indicate a fault.

Total primary consumption { 555A : 50 w.
555U : 50 w.

W/L switch in short wave position.

RESISTANCES.

Designation.	Value.	Code No.	Designation.	Value.	Code No.
R1	400 Ohm	28.773.660	R15	400 Ohm	28.770.860
R3	32,000 Ohm	28.770.400	R17	100 Ohm	28.773.600
R4	0.1 M. Ohm	28.773.900	R18	50,000 Ohm	28.812.790
R5	0.5 M. Ohm	28.773.970	R19	4,000 Ohm	28.773.760
R6	50,000 Ohm	28.773.870	R20	80,000 Ohm	28.770.440
R7	320 Ohm	28.773.650	R21	0.16 M. Ohm	28.773.920
R8	0.1 M. Ohm	28.773.900	R22	5 M. Ohm	28.771.270
R9	2 M. Ohm	28.771.230	R23	0.64 M. Ohm	28.773.980
R10	0.5 M. Ohm	28.814.970	R24	2 M. Ohm	28.771.230
R11	10,000 Ohm	28.773.80	R25	20,000 Ohm	28.773.830
R12	1 M. Ohm	28.770.550	R26	40 Ohm	28.773.560
R13	160 Ohm	28.771.750	R27	10 Ohm	28.770.730
R14	50 Ohm	28.773.570		2 × 20 in parallel }	

CONDENSERS.

Designation.	Value.	Code No.
C1	32 μF	28.182.400
C2	32 μF	28.182.400
C4	50,000 $\mu\mu\text{F}$	28.199.060†
C5	50,000 $\mu\mu\text{F}$	28.201.150
C6	50,000 $\mu\mu\text{F}$	28.201.150 or 40,000 $\mu\mu\text{F}$ 28.201.140
C7	11—490 $\mu\mu\text{F}$	} 28.216.020
C8	11—490 $\mu\mu\text{F}$	
C9	11—490 $\mu\mu\text{F}$	
C10	30 $\mu\mu\text{F}$	See Coils
C11	30 $\mu\mu\text{F}$	See Coils
C12	30 $\mu\mu\text{F}$	28.212.060
C13	50,000 $\mu\mu\text{F}$	28.201.150
C14	16 $\mu\mu\text{F}$	28.206.360
C15	12,500 $\mu\mu\text{F}$	28.199.000
C16	40,000 $\mu\mu\text{F}$	28.201.090
C17	50 $\mu\mu\text{F}$	28.206.240
C19	680 $\mu\mu\text{F}$	49.080.000
C20	1,525 $\mu\mu\text{F}$	28.193.040
C21	70+30 $\mu\mu\text{F}$	28.212.460
C22	70+30 $\mu\mu\text{F}$	See Coils
C23	70+30 $\mu\mu\text{F}$	28.212.460
C24	70+30 $\mu\mu\text{F}$	See Coils
C25	80 $\mu\mu\text{F}$	28.206.260
C26	10,000 $\mu\mu\text{F}$	28.201.080
C27 (555U)	64 $\mu\mu\text{F}$	28.206.250
C27	80 $\mu\mu\text{F}$	28.206.260
C28	25 μF	28.182.240
C29	50 $\mu\mu\text{F}$	28.206.240
C30	2,000 $\mu\mu\text{F}$	28.201.480
C31	70+30 $\mu\mu\text{F}$	See Coils
C32	10 $\mu\mu\text{F}$	28.206.340
C35	50,000 $\mu\mu\text{F}$	28.201.640
C37	70+30 $\mu\mu\text{F}$	28.212.460
C38	20,000 $\mu\mu\text{F}$	28.201.650
C39	50,000 $\mu\mu\text{F}$	28.199.060†
C40	50,000 $\mu\mu\text{F}$	28.199.060 or 40,000 $\mu\mu\text{F}$ 28.199.050
C41	50,000 $\mu\mu\text{F}$	28.199.060 or 64,000 $\mu\mu\text{F}$ 28.201.160
C50	4 $\mu\mu\text{F}$	28.206.530
C60 } 555U	20,000 $\mu\mu\text{F}$	28.199.780
C61 }	20,000 $\mu\mu\text{F}$	28.199.780

† or C4 and C39 = 64,000 $\mu\mu\text{F}$ 28.199.070

VALVES AND PILOT LAMPS

L1	L2	L3	L4	L5
EK2	EF9	EBL1	AZ1	EM1
L6 = 8045D - 00		L7 = 8045D - 00		